

Rubine™
ITALIA

REDEFINE THE WAY OF LIFE

CATALOGUE 2024 V.3

CULINARY EXPERIENCE
REDEFINED

Avant-Garde SERIES

TITAN



Modernize Your Kitchen with Our Cutting-Edge & Revolutionary T-Hood

With its functional and contemporary aesthetics, **TITAN** complements perfectly with your kitchen space. Embrace its exceptional features, positioning as "The Pinnacle of Futuristic Cooker Hood"; combining both Titanium Grey finishing and Champagne Gold embellishment.





BLDC MOTOR

Efficient - High Power Density and Energy-Saving
Quiet - Noise level as low as 48dB
Powerful - High Static Pressure up to 1,050Pa



I-LINK FUNCTION

Intelligence linkage between cooker hood & gas hob. The cooker hood is seamlessly activated when the gas hob is switched on.



TITAN SUCTION PLATE

The innovative & stunningly designed suction plate comes with NanoGarde Protection for effortless removal of smoke & grease.

RCH-TITAN-TG

Features

- T-Hood
- 1,950 m³/hr Suction Power
- Sensor Touch Control Panel
- 2 + 1 (X-Boost) Extraction Speed
- Oil Cup / Trap (outer)
- Charcoal Filter
- 1 (LED) Lamp
- Delay Timer

Technical Info

Product Dimension (mm)

896 W x 455 D x 622 - 992 H

BLDC Motor	1950m ³ /hr Suction Power	2+1 Extraction Speed
1 (LED) Lamp	Recirculating	Titanium Grey
NanoGarde	H ² Meltz (Heating Pad)	I-Link
Air Exchange	Smart Motion Sensor	X-Boost
Titan Suction Plate	DC-18 Ducting	

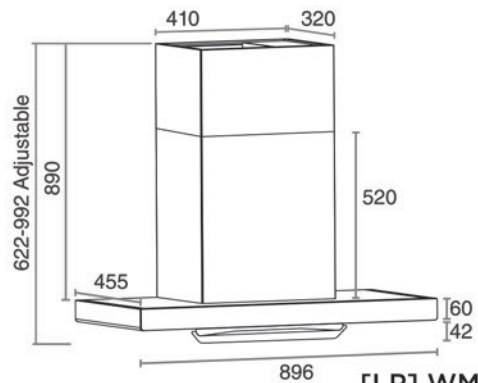

[LP] WM : RM 2,830
EM : RM 3,040

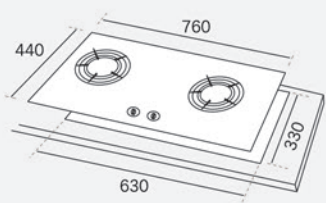
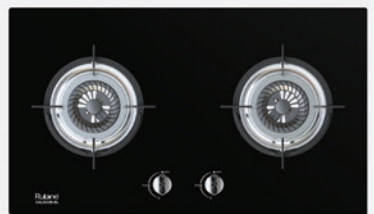

RGH-CALDO2B-BL

Features

- L:5.2 R:5.2 Flame Power (kW)
- Vortex / Twister Flame Style
- Tempered Glass Surface
- SS + Brass Burner
- FFD Protection
- Battery Ignition
- LPG Gas
- Cast Iron Pan Support
- Wok Stand

Technical Info

Product Dimension (mm): 760 W x 440 D
 Cut-out Dimension (mm): 630 W x 330 D

5.2kW Flame Power	Flame Failure Device (FFD) Protection	Battery Ignition	Vortex Flame Style	Pan Support With Wind Barricade
-------------------	---------------------------------------	------------------	--------------------	---------------------------------

[LP] WM : RM 860
EM : RM 920

2 ITEMS NOW
 WM : **RM 3,318**
 EM : **RM 3,558**

KITCHEN HOOD

Avant-Garde SERIES

ARTESAN

NEW

Trendsetting
Outlook Fused
with
State-of-the-Art
Technologies

Unleash your creativity and enliven a lavish lifestyle with the **ARTESAN** cooker hood. Admire its captivating charms with this new Pannelo Hood - **ARTESAN**.



MODERN, CAPTIVATING CHARMS
PANELLO HOOD





NANOGARDE TECHNOLOGY

- Nano Protection
- Easy Maintenance
- Fingerprint Resistance
- Wipe off stubborn oil & grease with ease



TITANIUM GREY BODY WITH BLACK GLASS PANEL



CHAMPAGNE GOLD CONTROL PANEL WITH HIGH-TECH FEATURES AND SMART MOTION SENSOR

RCH-ARTESAN-TG

Features

- Pannello Hood
- 2,050 m³/hr Suction Power
- 48dB Low Noise Level
- 1,100Pa High Static Pressure
- Sensor Touch Control Panel
- 2 + 1 (X-Boost) Extraction Speed
- Oil Cup / Trap (outer)
- 1 (LED) Lamp
- Delay Timer

Technical Info

Product Dimension (mm)

896 W x 320 D x 860 - 1240 H

BLDC Motor	2,050m ³ /hr Suction Power	2+1 Extraction Speed
1 (LED) Lamp	Titanium Grey	NanoGarde
H ² Meltz (Heating Pad)	I-Link	Air Exchange
Smart Motion Sensor	X-Boost	DC-18 Ducting

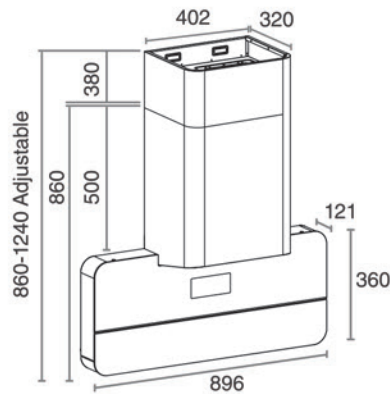

[LP] WM : RM 3,950
EM : RM 4,240

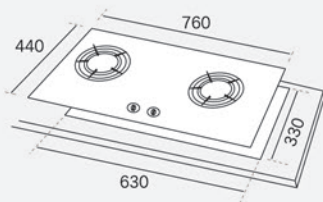
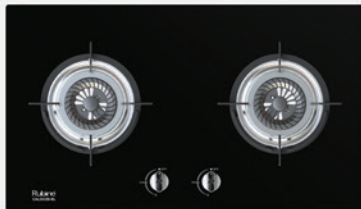

RGH-CALDO2B-BL

Features

- L:5.2 R:5.2 Flame Power (kW)
- Vortex / Twister Flame Style
- Tempered Glass Surface
- SS + Brass Burner
- FFD Protection
- Battery Ignition
- LPG Gas
- Cast Iron Pan Support
- Wok Stand

Technical Info

Product Dimension (mm): 760 W x 440 D
Cut-out Dimension (mm): 630 W x 330 D

5.2kW Flame Power	Flame Failure Device (FFD) Protection	Battery Ignition	Vortex Flame Style	Pan Support With Wind Barricade
-------------------	---------------------------------------	------------------	--------------------	---------------------------------

[LP] WM : RM 860
EM : RM 920

2 ITEMS NOW
WM : **RM 4,328**
EM : **RM 4,638**

Avant-Garde SERIES

ROSSETA



Sleek *Incassato*
Design with
Intelligent
Functions -
A Touch of
L-Shaped Brilliance
with Strong
Extraction Power

Discover the new Avant-Garde hood - **ROSSETA**. Enjoy a grease-free kitchen with its auto-lifting quick extraction chamber for enhanced practicality and smart controls explicitly tailored to various cooking needs with silent operation.



● **BLDC MOTOR**
Efficient - High Power Density and Energy-Saving
Quiet - Noise level as low as 48dB
Powerful - High Static Pressure up to 1,050Pa



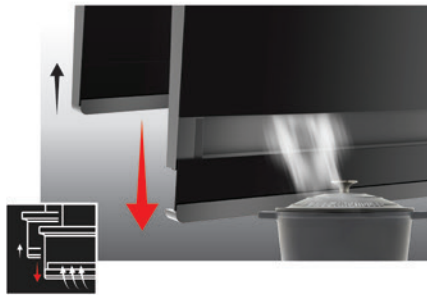

AUTO-LIFTING QUICK EXTRACTION CHAMBER

The auto-lifting quick extraction chamber will drop down to clear smoke & grease while cooking and elegantly close when idle.



H²MELTZ TECHNOLOGY

Activate for 10 minutes to melt stubborn grease at 80°C. Cut Down 80% Cleaning Time.



AIR EXCHANGE

Removal of residual smoke & odour in a 3-Cycle Mode within 1 hour to restore fresh air automatically.

RCH-ROSSETA-TG

Features

- L-Hood
- 2,200 m³/hr Suction Power
- Sensor Touch Control Panel
- 2 + 1 (X-Boost) Extraction Speed
- Oil Cup / Trap
- Charcoal Filter
- 2 (LED) Lamp
- Delay Timer

Technical Info

Product Dimension (mm)

900 W x 345 D x 1060 - 1435 H

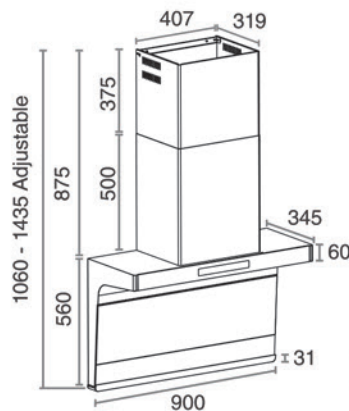
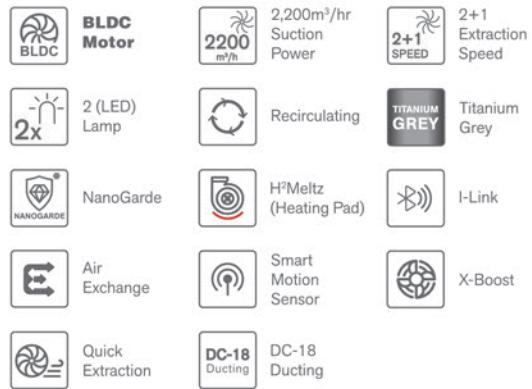

[LP] WM : RM 3,630
EM : RM 3,900

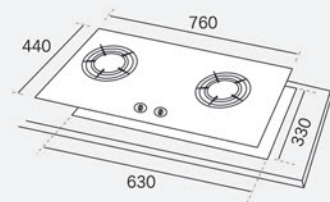
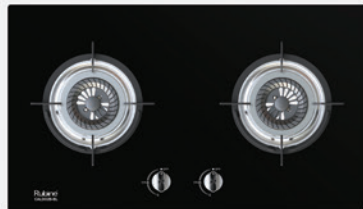

RGH-CALDO2B-BL

Features

- L:5.2 R:5.2 Flame Power (kW)
- Vortex / Twister Flame Style
- Tempered Glass Surface
- SS + Brass Burner
- FFD Protection
- Battery Ignition
- LPG Gas
- Cast Iron Pan Support
- Wok Stand

Technical Info

Product Dimension (mm): 760 W x 440 D
Cut-out Dimension (mm): 630 W x 330 D



[LP] WM : RM 860
EM : RM 920

2 ITEMS NOW
WM : RM 4,038
EM : RM 4,328

Cool-Breeze SERIES

MEERA

NEW

Powerful
Performance.
Twin-Motor,
Double Delights!

Unleash the power of twin-motor for superior performance - experience double efficiency & delights in every cooking moment.



SUCTION
2,200
m³/hr
POWER

INTUITIVE
GRAPHICAL DISPLAY PANEL





TWIN-MOTOR

Customize your cooking experience with wider suction coverage. You can operate each motor individually to perfectly suit your culinary needs.



COOL-BREEZE

- Breeze-up your cooking experience**
- Feel the cool-breeze with just a touch
- Improve Comfort**
- Provide a soothing breeze and a comfortable cooking environment



NANOGARDE TECHNOLOGY

- Nano Protection
- Easy Maintenance
- Fingerprint Resistance
- Wipe off stubborn oil & grease with ease

RCH-MEERA-BL

Features

- Slanted Hood
- 2,200 m³/hr Suction Power
- Sensor Touch Control Panel
- 2 + 1 (X-Boost) Extraction Speed
- Oil Cup / Trap (outer)
- Charcoal Filter
- 2 (LED) Lamp
- Delay Timer

Technical Info

Product Dimension (mm)
900 W x 395 D x 824 - 1153 H

Twin-Motor	2200m ³ /hr Suction Power	2+1 Extraction Speed
2 (LED) Lamp	Recirculating	Cool-Breeze
H ² Meltz (Heating Pad)	I-Link	Air Exchange
Smart Motion Sensor	Ion-Balancer	X-Boost
NanoGarde	DC-18 Ducting	

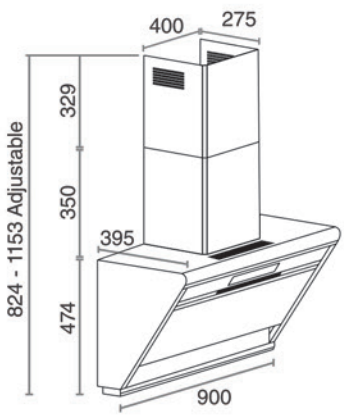

[LP] WM : RM 3,200
EM : RM 3,440

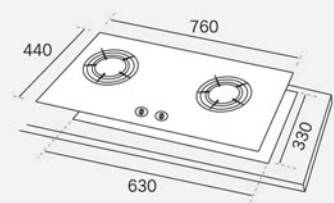
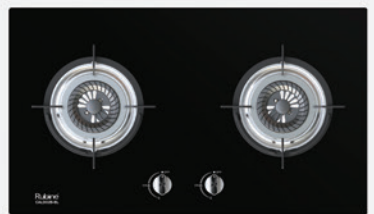

RGH-CALDO2B-BL

Features

- L:5.2 R:5.2 Flame Power (kW)
- Vortex / Twister Flame Style
- Tempered Glass Surface
- SS + Brass Burner
- FFD Protection
- Battery Ignition
- LPG Gas
- Cast Iron Pan Support
- Wok Stand

Technical Info

Product Dimension (mm): 760 W x 440 D
Cut-out Dimension (mm): 630 W x 330 D

5.2kW Flame Power	Flame Failure Device (FFD) Protection	Battery Ignition	Vortex Flame Style	Pan Support With Wind Barricade
-------------------	---------------------------------------	------------------	--------------------	---------------------------------

[LP] WM : RM 860
EM : RM 920

2 ITEMS NOW
WM : **RM 3,658**
EM : **RM 3,918**

KITCHEN HOOD

Cool-Breeze SERIES

LUSTRO



Redefine Urban Kitchens with Sleek, Contemporary & Efficient Pannelo Hood

Contemporary & highly efficient, a perfect match
for urban kitchens. Redefining cooking space
with modern flairs.

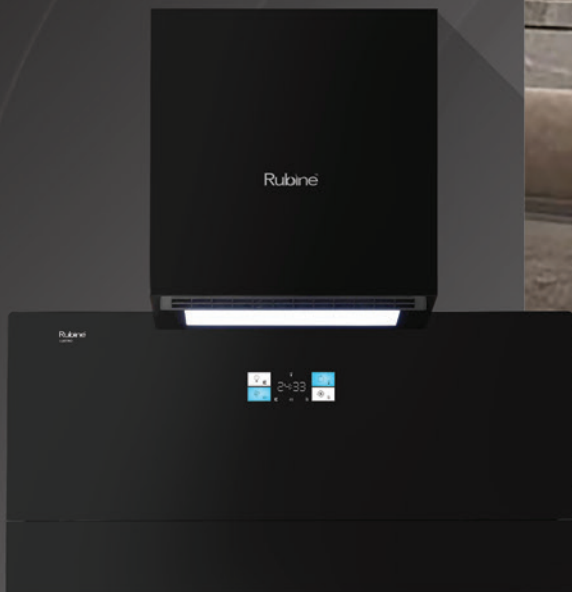



BLDC MOTOR

Efficient - High Power Density and Energy-Saving
Quiet - Noise level as low as 48dB
Powerful - High Static Pressure up to 1,100Pa

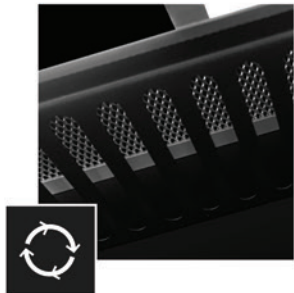

CASSETTE CHARCOAL FILTER FOR INTERNAL RECIRCULATION

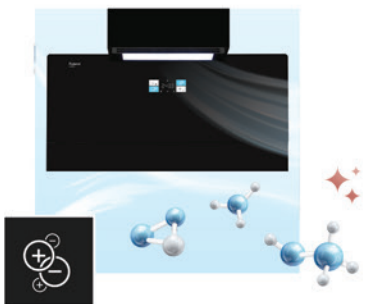

ION-BALANCER

Anions are produced to balance static charges from pollutants. This will eliminate odours and sanitise the air.

RCH-LUSTRO-BL

Features

- Pannelo Hood
- 2,050 m³/hr Suction Power
- Sensor Touch Control Panel
- 2 + 1 (X-Boost) Extraction Speed
- Oil Cup / Trap (outer)
- Charcoal Filter
- 1 (LED) Lamp
- Delay Timer

Technical Info

Product Dimension (mm)
 900 W x 351 D x 1054 - 1434 H

BLDC Motor	2050m ³ /hr Suction Power	2+1 Extraction Speed
1 (LED) Lamp	Recirculating	Cool-Breeze
H ² Meltz (Heating Pad)	I-Link	Air Exchange
Smart Motion Sensor	Ion- Balancer	X-Boost
NanoGarde	DC-18 Ducting	

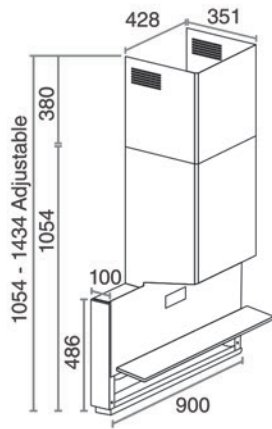

[LP] WM : RM 3,800
 EM : RM 4,080

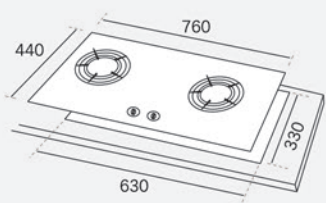
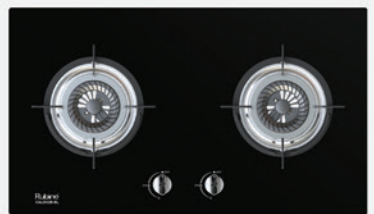

RGH-CALDO2B-BL

Features

- L:5.2 R:5.2 Flame Power (kW)
- Vortex / Twister Flame Style
- Tempered Glass Surface
- SS + Brass Burner
- FFD Protection
- Battery Ignition
- LPG Gas
- Cast Iron Pan Support
- Wok Stand

Technical Info

Product Dimension (mm): 760 W x 440 D
 Cut-out Dimension (mm): 630 W x 330 D

5.2kW Flame Power	Flame Failure Device (FFD) Protection	Battery Ignition	Vortex Flame Style	Pan Support With Wind Barricade
-------------------	---------------------------------------	------------------	--------------------	---------------------------------

[LP] WM : RM 860
 EM : RM 920

2 ITEMS NOW
 WM : **RM 4,188**
 EM : **RM 4,488**

KITCHEN HOOD

Cool-Breeze SERIES

CASSERA

NEW

Compact Slanted
Hood with
Cool-Breeze
Technology

Compact and alluring design to fit your kitchen
splendidly to provide a soothing and comfortable
cooking environment.



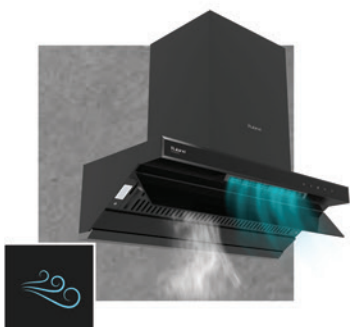

RCH-CASSERA-90BL

Features

- Compact Slanted Hood
- 1,650 m³/hr Suction Power
- Sensor Touch Control Panel
- 2 + 1 (X-Boost) Extraction Speed
- Ergonomic Baffle Oil Filter
- Oil Cup / Trap (outer)
- Charcoal Filter
- 2 (LED) Lamp
- Delay Timer

COOL-BREEZE TECHNOLOGY

Cool-Breeze blowing from the upper chamber provides you with a soothing and comfortable cooking environment.



BEVELED GLASS PANEL

Beveled glass panel brings modernity to your kitchen.



SMART MOTION SENSOR

With a wave of your palm, you can turn ON the X-Boost mode and alter the extraction speeds.

Technical Info

Product Dimension (mm)

900 W x 405 D x 760 - 1050 H

1650m ³ /hr Suction Power	2+1 Extraction Speed	2 (LED) Lamp
Cool-Breeze	Beveled Glass Panel	Smart Motion Sensor
H ² Meltz (Heating Pad)	Recirculating	X-Boost
DC-18 Ducting	DC-18 Ducting	

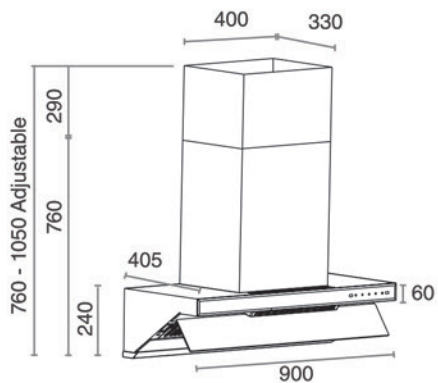

[LP] WM : RM 2,930
EM : RM 3,150

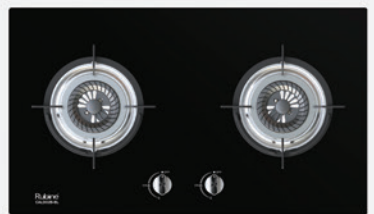

RGH-CALDO2B-BL

Features

- L:5.2 R:5.2 Flame Power (kW)
- Vortex / Twister Flame Style
- Tempered Glass Surface
- SS + Brass Burner
- FFD Protection
- Battery Ignition
- LPG Gas
- Cast Iron Pan Support
- Wok Stand

Technical Info

Product Dimension (mm): 760 W x 440 D
Cut-out Dimension (mm): 630 W x 330 D

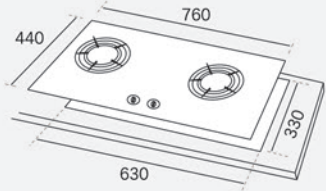

5.2kW Flame Power	Flame Failure Device (FFD) Protection	Battery Ignition	Vortex Flame Style	Pan Support With Wind Barricade
-------------------	---------------------------------------	------------------	--------------------	---------------------------------

[LP] WM : RM 860
EM : RM 920

2 ITEMS NOW
WM : RM 3,408
EM : RM 3,648

NEORA



Minimalist and Premium Matte Black Cooker Hood



H²MELTZ TECHNOLOGY + X-BOOST

Activate for 10 minutes to melt stubborn grease at 80°C. Cut down 80% cleaning time.



QUICK EXTRACTION

The perfect position of the extraction chamber provides powerful suction that absorbs smoke, grease & odour quickly while you cook.

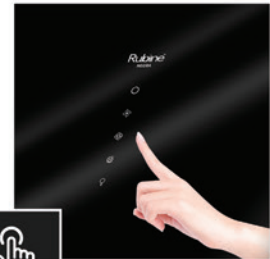

SENSOR TOUCH CONTROL

RCH-NEORA-90BL

Features

- Slanted Hood
- 1,600 m³/hr Suction Power
- Sensor Touch Control Panel
- 2 + 1 (X-Boost) Extraction Speed
- Ergonomic Baffle Oil Filter
- Oil Cup/ Trap (outer)
- Charcoal Filter
- 2 (LED) Lamp
- Delay Timer

Technical Info

Product Dimension (mm)
896 W x 443 D x 943 - 1318 H

[LP] WM : RM 1,860
EM : RM 2,000

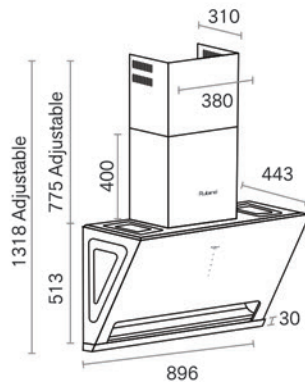

	1600m ³ /hr Suction Power		2+1 Extraction Speed		2 (LED) Lamp
	Recirculating		H ² Meltz (Heating Pad)		X-Boost
	Quick Extraction		Sensor Touch Control		DC-18 Ducting



RGH-CALDO2B-BL

[LP] WM : RM 860
EM : RM 920

2 ITEMS NOW

WM : **RM 2,448**
EM : **RM 2,628**

ASPIRA



Excellent Extraction Capacity with Dual-Suction Chamber Technology

RCH-ASPIRA-90SS

Features

- Slanted Hood
- 1,500 m³/hr Suction Power
- Sensor Touch Control Panel
- 2 + 1 (X-Boost) Extraction Speed
- Ergonomic Baffle Oil Filter
- Oil Cup/ Trap (outer)
- Charcoal Filter
- 1 (LED) Lamp
- Delay Timer

Technical Info

Product Dimension (mm)
895 W x 419 D x 970-1260 H

[LP] WM : RM2,000
EM : RM2,150

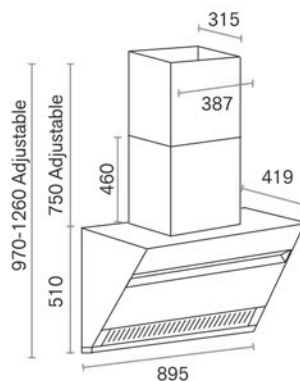

- | | | | | | |
|--|--------------------------------------|--|----------------------|--|---------------------|
| | 1500m ³ /hr Suction Power | | 2+1 Extraction Speed | | 1 (LED) Lamp |
| | Recirculating | | X-Boost | | Smart Motion Sensor |
| | Dual-Suction | | DC-18 Ducting | | |



RGH-CALDO2B-BL

[LP] WM : RM 860
EM : RM 920

2 ITEMS NOW

WM : RM 2,568
EM : RM 2,758

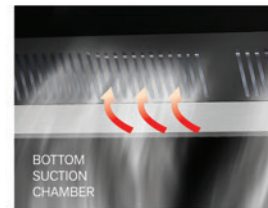

DUAL-SUCTION

Dual-Suction chamber for excellent & complete extraction.



SMART MOTION SENSOR

With a wave of your palm, you can turn ON/OFF the hood without having to touch the control panel.

KITCHEN HOOD
TITAN
ARTESAN
ROSSETTA
MEERA
LUSTRO
CASSERA
NEORA
ASPIRA
MONZA X
MARK X
SIROCCO XR
THORA
BOXLINE XR
MARIA

NEW KITCHEN HOOD

MONZA X



The Rebirth of An Icon:
Unveiling the New MONZA X

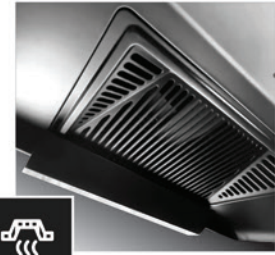

CONCAVE SUCTION CHAMBER

For a better smoke extraction coverage.



SMART MOTION SENSOR & X-BOOST

With a wave of your palm, you can turn ON/OFF the hood without having to touch the control panel.



MODERN & MINIMALIST DESIGN

REDISCOVER NEW ELEGANCE WITH PREMIUM BLACK OUTLOOK

RCH-MONZA X-BL

Features

- T - Hood
- 1,700 m³/hr Suction Power
- Sensor Touch Control Panel
- 2 + 1 (X-Boost) Extraction Speed
- Concave Oil Filter
- Oil Cup / Trap (outer)
- Charcoal Filter
- 1 (LED) Lamp
- Delay Timer

Technical Info

Product Dimension (mm)
896 W x 455 D x 580 - 950 H

[LP] WM : RM 1,900
EM : RM 2,040

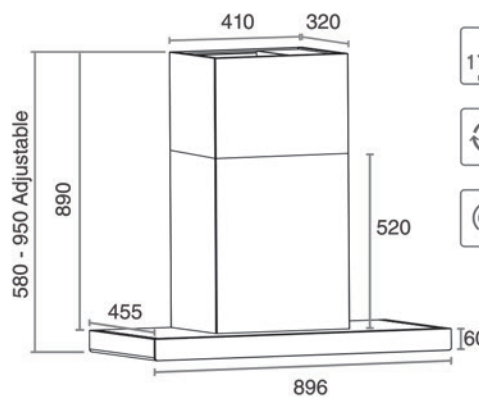

- 1700 m³/hr Suction Power
- 2+1 SPEED
- 2+1 Extraction Speed
- 1 (LED) Lamp
- Recirculating
- H²Meltz (Heating Pad)
- X-Boost
- Smart Motion Sensor
- Concave Filter
- DC-18 Ducting



RGH-CALDO2B-BL

[LP] WM : RM 860
EM : RM 920

2 ITEMS NOW

WM : RM 2,478
EM : RM 2,658

NEW

MARK X



Experience the New MARK X
Where Modern Advancements
Bond with Simplified Maintenance

RCH-MARK X-BL

Features

- Slanted Hood
- 1,500 m³/hr Suction Power
- Sensor Touch Control Panel
- 2 +1 (X-Boost) Extraction Speed
- Ergonomic Baffle Oil Filter
- Oil Cup / Trap (outer)
- Charcoal Filter
- 1 (LED) Lamp
- Delay Timer

Technical Info

Product Dimension (mm)
896 W x 443 D x 943 - 1318 H

[LP] WM : RM 1,680
EM : RM 1,800

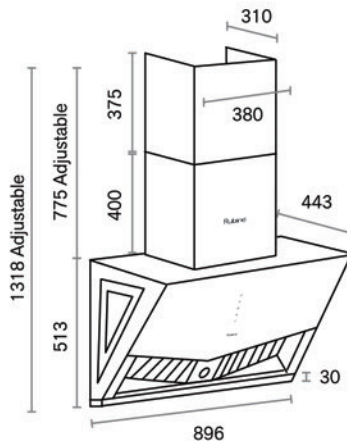

- 1500 m³/hr Suction Power
- 2+1 SPEED Extraction Speed
- 1 (LED) Lamp
- DUAL-STEP LED
- Recirculating
- H²Meltz (Heating Pad)
- X-Boost
- EASY REMOVABLE FILTER PLATE
- Quick Extraction
- DC-18 Ducting



RGH-VISTA2B-BL

[LP] WM : RM 800
EM : RM 860

2 ITEMS NOW

WM : RM 2,228
EM : RM 2,388



H²MELTZ TECHNOLOGY

Activate for 10 minutes to melt stubborn grease at 80°C. Cut down 80% cleaning time.

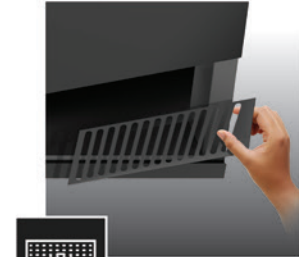

EASY MAGNETIC Baffle PLATE

Easily detachable to save time for regular maintenance and cleaning.



DUAL-STEP LED LAMP

Added convenience and better lighting for cooking activities in the kitchen.

KITCHEN HOOD
TITAN
ARTESAN
ROSSETTA
MEERA
LUSTRO
CASSERA
NEORA
ASPIRA
MONZA X
MARK X
SIROCCO XR
THORA
BOXLINE XR
MARIA

NEW KITCHEN HOOD

SIROCCO XR

Premium Matte Black Finish



Enjoy Smoke-Free Quick Extraction Performance with 350 Incassato Design

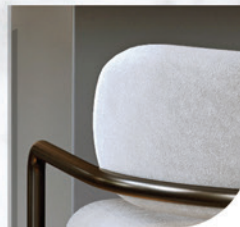

H²MELTZ TECHNOLOGY

Activate for 10 minutes to melt stubborn grease at 80°C. Cut down 80% cleaning time.



350 INCASSATO

Control Panel of the hood can now be perfectly in-line with the kitchen cabinet.



OIL-FREE WALL

The design of the cooker hood covers your wall. Hence oil that would otherwise end up on your wall would flow into the designated oil cup.

RCH-SIROCCO XR-BL

Features

- L - Hood
- 1,800 m³/hr Suction Power
- Sensor Touch Control Panel
- 2 + 1 (X-boost) Extraction Speed
- Oil Cup / Trap (outer)
- Charcoal Filter
- 2 (LED) Lamp
- Delay Timer

Technical Info

Product Dimension (mm)
896 W x 350 D x 1057 - 1385 H

[LP] WM : RM 2,820
EM : RM 3,030

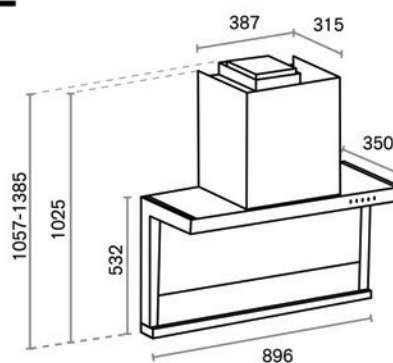

	1800m³/hr Suction Power		2+1 Extraction Speed		2 (LED) Lamp
	Recirculating		Quick Extraction		DC-18 Ducting
	X-Boost		Smart Motion Sensor		Invisible Control Panel
	Easy Maintenance		Air Exchange		350 Incassato
	H²Meltz (Heating Pad)				



RGH-VISTA2B-BL

[LP] WM : RM 800
EM : RM 860

2 ITEMS NOW

WM : RM 3,248
EM : RM 3,488

THORA



Innovative Hybrid Filter
Makes Cooking & Cleaning
A Fuss-Free Experience

RCH-THORA-SS

Features

- Pyramid T - Hood
- 1,500 m³/hr Suction Power
- Sensor Touch Control Panel
- 2+1 (X-boost) Extraction Speed
- Hybrid (Patented) Oil Filter
- Oil Cup / Trap (outer)
- Charcoal Filter
- 2 (LED) Lamp
- Delay Timer

Technical Info

Product Dimension (mm)
896 W x 525 D x 580 - 850

[LP] WM : RM 2,760
EM : RM 2,960

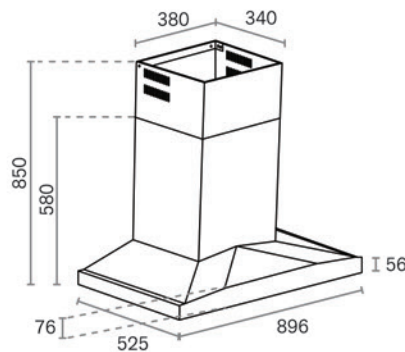

RGH-VISTA2B-BL

[LP] WM : RM 800
EM : RM 860

2 ITEMS NOW

WM : RM 3,198
EM : RM 3,428

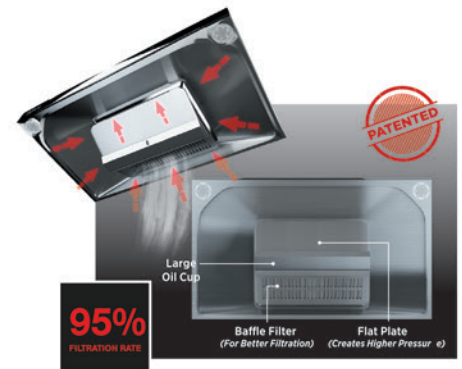

95% HYBRID FILTRATION SYSTEM

The whole new innovative Hybrid Filter is paired with a flat plate and baffle filter. The design is created to channel the surrounding air pressure from the flat plate towards the baffle filter area for faster and more efficient extraction and oil filtration.



H²MELTZ TECHNOLOGY

Activate for 10 minutes to melt stubborn grease at 80°C. Cut down 80% cleaning time.



ION-BALANCER

Anions are produced to balance static charges from pollutants. This will eliminate odours and sanitise the air.



NEW KITCHEN HOOD

BOXLINE XR



An Essential & Dependable Companion,
where Simplicity Meets Productivity

RCH-BOXLINE XR-90SS

Features

- T - Hood
- 1,600 m³/hr Suction Power
- Sensor Touch Control Panel
- 2 + 1 (X-Boost) Extraction Speed
- Pyramidal Oil Filter
- Oil Cup / Trap (outer)
- Charcoal Filter
- 2 (LED) Lamp
- Delay Timer

Technical Info

Product Dimension (mm)
897 W x 511 D x 558 - 808 H

[LP] WM : RM 1,760
EM : RM 1,890

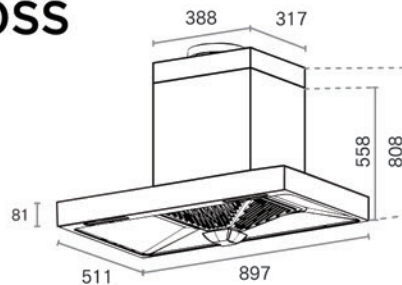

	1600m ³ /hr Suction Power		2+1 Extraction Speed		2 (LED) Lamp
	Recirculating		DC-18 Ducting		X-Boost
	Beveled Glass Panel		Invisible Control Panel		Easy Maintenance
	Smart Motion Sensor		H ² Meltz (Heating Pad)		



H²MELTZ TECHNOLOGY

Activate for 10 minutes to melt stubborn grease at 80°C. Cut down 80% cleaning time.



SMART MOTION SENSOR & X-BOOST

With a wave of your palm, you can turn ON/OFF the hood without having to touch the control panel.



EASY MAINTENANCE

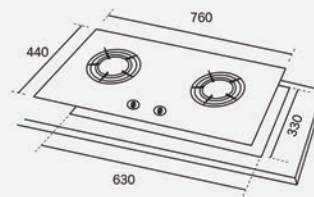

RGH-VISTA2B-BL

- Features**
- L:5.0 R:5.0 Flame Power (kW)
 - Vortex / Twister Flame Style
 - Tempered Glass Surface
 - Stainless Steel + Brass Burner
 - FFD Protection
 - Battery Ignition
 - LPG Gas
 - Cast Iron Pan Support
 - Wok Stand

Technical Info
Product Dimension (mm): 760 W x 440 D
Cut-out Dimension (mm): 630 W x 330 D

-
-
-
-

[LP] WM : RM 800
EM : RM 860

2 ITEMS NOW

WM : RM 2,298
EM : RM 2,468

MARIA



Less Cleaning Work,
More Cooking Time

RCH-MARIA-SS

Features

- Arch-Glass
- 1,200 m³/hr Suction Power
- Sensor Touch Control Panel
- 3 Extraction Speed
- Pyramidal Oil Filter
- Oil Cup / Trap (outer)
- Charcoal Filter
- 2 (LED) Lamp
- Delay Timer

Technical Info

Product Dimension (mm)
896 W x 500 D x 567 - 967 H

[LP] WM : RM 1,760
EM : RM 1,890

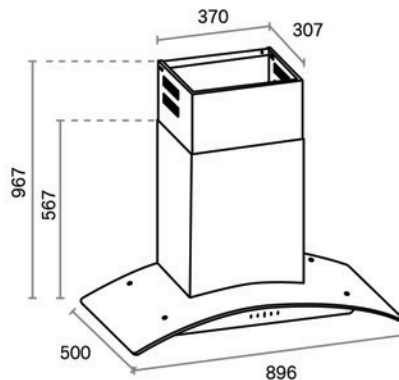

- 1200 m³/hr Suction Power
- 3 SPEED 3 Extraction Speed
- 2x 2 (LED) Lamp
- Recirculating
- DC-12 Ducting
- H²Meltz (Heating Pad)

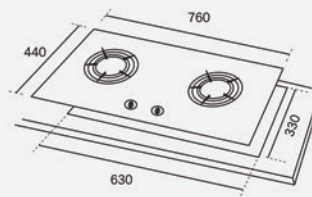

RGH-BRAVA2B-BL

- L:4.5 R:4.5 Flame Power (kW)
- Vortex / Twister Flame Style
- Tempered Glass Surface
- Stainless Steel + Brass Burner
- FFD Protection
- Battery Ignition
- LPG Gas
- Cast Iron Pan Support
- Wok Stand

Product Dimension (mm): 760 W x 440 D
Cut-out Dimension (mm): 630 W x 330 D

- 4.5kW Flame Power
- Flame Failure Device (FFD) Protection
- Battery Ignition
- Vortex Flame Style

[LP] WM : RM 780
EM : RM 830

2 ITEMS NOW
WM : RM 2,288
EM : RM 2,448



H²MELTZ TECHNOLOGY

Activate for 10 minutes to melt stubborn grease at 80°C. Cut down 80% cleaning time.



EASY MAINTENANCE

It is maintenance-friendly and easy to clean the fan blade and motor as the panel that heats up to 80°C reduces the amount of oil collecting on the oil cup.



ARCH-GLASS DESIGN

The Arc-Shaped hood and stainless steel filter achieves high oil-filtration and odour-reduction. It also improves air quality while protecting walls and surface against discoloration and damage.

KITCHEN HOOD

Avant-Garde SERIES

ARTESAN



MAINTENANCE TIPS

① SURFACE CLEANING

By using soft cloth & non-abrasive detergent to clean oil and stain on surface regularly to maintain hygiene.

② OIL FILTER CLEANING

Empty the oil tray and clean baffle filter with warm water regularly and non-abrasive detergent to maintain the suction efficiency.

③ CHARCOAL FILTER

Recommended to replace it at least once a year to ensure peak performance. Charcoal filter is non-washable, you can purchase it with our after-sales department.

④ HOOD MOTOR

Contact our after-sales department for motor servicing & maintenance at least once a year to ensure consistent suction and performance.

RECOMMENDED HOOD INSTALLATION HEIGHT

① T - HOOD/
ARCH-GLASS HOOD



② SLANTED HOOD



③ L - HOOD

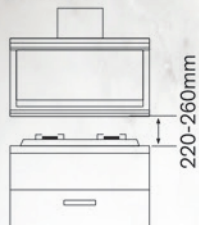

④ COMPACT-
SLANTED HOOD



⑤ PANNELLO HOOD



NEW RANGE COOKER

GRANDERA

— Range Cooker —

PROFESSIONAL CHOICE! FREESTANDING COOKER WITH TWIN-OVEN



ROBUST & VERSATILE

The high-quality range cooker enables you to cook multiple dishes with both gas burners and ovens simultaneously.



COOKTOP WITH ITALIAN

SABAF BURNER WITH FISH BURNER

The FIVE burners with different flame powers.



TWIN-OVEN WITH 83L & 45L CAPACITY

Preparing TWO dishes at the same time!

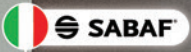

GRILL & COOK



ROTISSERIE & TELESCOPIC RUNNER

Rotisserie ensures the meat is evenly cooked and perfectly browned on all sides. Telescopic Runner ensures a hassle-free, smooth and safe slide out of your dishes from the oven or bastes it.

TOUCH ME!



SENSOR TOUCH CONTROL & TIMER

A user-friendly function that allows you to easily control & adjust the temperature and cooking time.

SPLASHBACK



SPLASHBACK DESIGN

To reduce cooking grease splattering to the kitchen wall.



RRC-GRANDERA-618-SS



RRC-GRANDERA-PRO918-SS



RRC-GRANDERA-PRO928-SS

Gas Hob Features

Flame Power (kW)
Flame Style
Surface Material
Burner Material
FFD Protection
Ignition
Type of Gas
Pan Support
Wok Stand
Product Dimension (W x D x H mm)

LR:1.75 LF:3.7 RR:1.75 RF:1.0
Straight
Stainless Steel
SABAF Burner
✓
Electric
LPG
Cast Iron
Cast Iron
600 x 600 x 900

LR:1.75 LF:3.0 M:3.7 RR:1.75 RF:1.0
Straight
Stainless Steel
SABAF Burner with Fish Burner
✓
Electric
LPG
Cast Iron
Cast Iron
900 x 600 x 900

LR:1.75 LF:3.0 M:3.7 RR:1.75 RF:1.0
Straight
Stainless Steel
SABAF Burner with Fish Burner
✓
Electric
LPG
Cast Iron
Cast Iron
900 x 600 x 900

Oven Features

Cooking Programme / Function
Capacity (L)
Electronic Control & Display
Oven Light
Time Control
Removable Door
Shelf Side Support
Cavity Material
Child Lock
Energy Efficiency

8
67L
✓
2
✓
✓
5
Enamel
✓
A

8
118L
✓
2
✓
✓
5
Enamel
✓
A

8
83L + 45L
✓
2
✓
✓
5
Enamel
✓
A

Highlight Features

Door Glass Layer
Telescopic Runner
Cooling System
Rotisserie & Turnspit
Storage Compartment
Splash Back

3
✓
✓
✓
✓
✓
✓

3
✓
✓
✓
✓
✓
✓

3
✓
✓
X
✓
✓
✓

8 Cooking Programme / Function:

- Lamp
- Top & Bottom Heat
- Button Heat with Fan Assisted
- Top Heat
- Top Grill
- Top Grill with Fan Assisted
- Circular Heat with Fan
- Defrosting

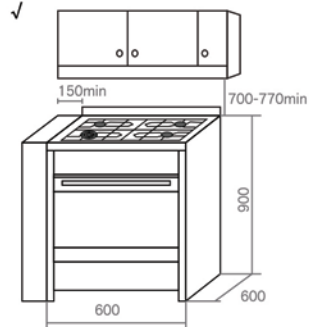

67L Large Capacity
SABAF Burner

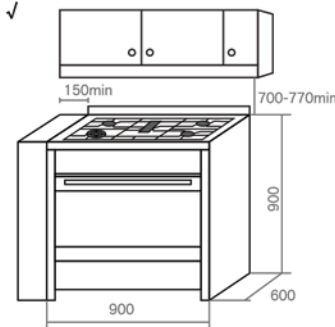

118L Large Capacity
SABAF Burner + Fish Burner

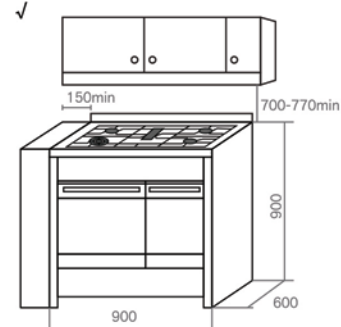

83L + 45L Grandera Twin-Oven Capacity
SABAF Burner + Fish Burner

Features apply to all models above:

- Flame Power up to 3.7kW
- Electric Ignition
- Flame Failure Devices (FFD) Protection
- 8 Functions
- Sensor Touch
- Timer
- Telescopic Runner
- Rotisserie & Turnspit
- Quality 3-Layers Glass Door
- A-Class Energy Efficiency
- Child Lock
- 5 Shelves
- Cooling System
- Splashback Design

[LP] WM : RM 6,200
EM : RM 6,640

[LP] WM : RM 8,900
EM : RM 9,520

[LP] WM : RM 9,900
EM : RM 10,590

GAS HOB





FASCO

SERIES

GAS HOB

MAINTENANCE TIPS

① GAS HOB SURFACE
(GLASS)

Glass surface is easy to clean. Make sure to use only soft cloth / sponge with non-abrasive detergent to avoid damage / scratch the surface.

② GAS HOB SURFACE
(STAINLESS STEEL)

Clean by using soft cloth / sponge with non-abrasive detergent as detergent with acidic nature might damage / scratch the stainless steel surface.

③ CLEAN UP SPILL AS
SOON AS IT OCCURS

Do not use cold water on hot surface as it will create thermal shock that can reduce the life span of the glass. Handle carefully when surface is hot.

④ CLEANING OF BURNER
RING & STAND

Use soft sponge with non-abrasive detergent to do regular cleaning. Remember to let dry before placing it back to the hob.

GAS HOB

FASCO

SERIES

NEW

**FAST &
CONVERGING
FLAME WITH
CONCENTRA PAN
SUPPORT
BUILT-IN GAS HOB**

Experience lightning-fast ignition and converging flame coverage for better burning efficiency and uniform heat distribution.

NEW



Premium

**TITANIUM GREY
STAINLESS STEEL
SURFACE**

5.5kW

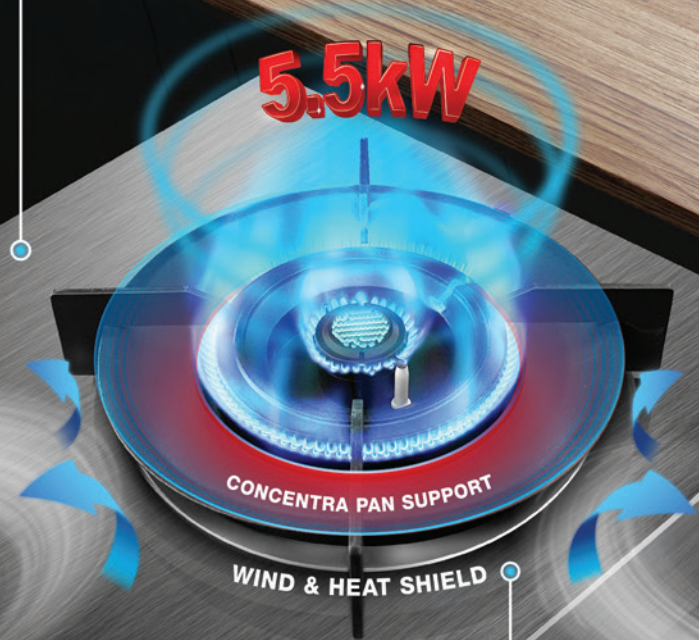

NEW



Premium
SETAKERA
GLASS SURFACE



NANO COATING
Easy cleaning & reduce water mark



FINGERPRINT RESISTANCE



FASCO FLAME
Higher dritto style flame provides concentrate and powerful heat distribution.



CONCENTRA PAN SUPPORT
Enhanced thermal efficiency up to 63% and effectively reduces external wind interference.



CHAMPAGNE GOLD ALUMINIUM FRAME



3-BURNERS PARABOLIC DESIGN
Parabolic design for a more versatile cooking space.



SMART TIMER WITH BATTERY INDICATOR



NEW

BLACK WATER TRAY FOR PREMIUM AESTHETIC

GAS HOB

FASCO SERIES

2-BURNER SERIES

3-BURNER SERIES

PRODUCT FEATURED: RGH-FASCO+3B-86SK

RGH-FASCO2B-SK

- Features**
- L:5.5 R:5.5 Flame Power (kW)
 - Dritto / Straight Flame Style
 - SETAKERA Glass with Champagne Gold Aluminium Frame
 - Brass Burner
 - FFD Protection
 - Battery Ignition
 - LPG Gas
 - Cast Iron Pan Support
 - Wok Stand
- Technical Info**
- Product Dimension (mm): 780 W x 460 D
 - Cut-out Dimension (mm): 650-750 W x 350-430 D

[LP] WM : RM 1,620 WM : RM **680**
EM : RM 1,740 EM : RM **730**

RGH-FASCO+2B-86SK

- Features**
- L:5.5 R:5.5 Flame Power (kW)
 - Dritto / Straight Flame Style
 - SETAKERA Glass with Champagne Gold Aluminium Frame
 - Brass Burner
 - FFD Protection
 - Battery Ignition
 - LPG Gas
 - Cast Iron Pan Support
 - Wok Stand
- Technical Info**
- Product Dimension (mm): 860 W x 500 D
 - Cut-out Dimension (mm): 800-830 W x 440-470 D

[LP] WM : RM 1,980 WM : RM **1,010**
EM : RM 2,120 EM : RM **1,080**

RGH-FASCO+3B-86SK

- Features**
- L:4.0 M:2.0 R:5.5 Flame Power (kW)
 - Dritto / Straight Flame Style
 - SETAKERA Glass with Champagne Gold Aluminium Frame
 - Brass Burner
 - FFD Protection
 - Battery Ignition
 - LPG Gas
 - Cast Iron Pan Support
 - Wok Stand
- Technical Info**
- Product Dimension (mm): 860 W x 500 D
 - Cut-out Dimension (mm): 700-830 W x 400-470 D

[LP] WM : RM 2,160 WM : RM **1,170**
EM : RM 2,320 EM : RM **1,260**

RGH-FASCO2B-TG

- Features**
- L:5.5 R:5.5 Flame Power (kW)
 - Dritto / Straight Flame Style
 - Titanium Grey Stainless Steel Surface
 - Brass Burner
 - FFD Protection
 - Battery Ignition
 - LPG Gas
 - Cast Iron Pan Support
 - Wok Stand
- Technical Info**
- Product Dimension (mm): 780 W x 460 D
 - Cut-out Dimension (mm): 650-750 W x 350-430 D

[LP] WM : RM 1,660 WM : RM **720**
EM : RM 1,780 EM : RM **770**

RGH-FASCO+3B-86TG

- Features**
- L:4.0 M:2.0 R:5.5 Flame Power (kW)
 - Dritto / Straight Flame Style
 - Titanium Grey Stainless Steel Surface
 - Brass Burner
 - FFD Protection
 - Battery Ignition
 - LPG Gas
 - Cast Iron Pan Support
 - Wok Stand
- Technical Info**
- Product Dimension (mm): 860 W x 500 D
 - Cut-out Dimension (mm): 700-830 W x 400-470 D

[LP] WM : RM 2,220 WM : RM **1,220**
EM : RM 2,380 EM : RM **1,310**



PREMIUM SETAKERA Glass with Champagne Gold Aluminium Frame

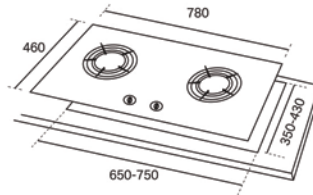

- 5.5kW Flame Power
- Flame Failure Device (FFD) Protection
- Battery Ignition
- FASCO Dritto Flame Style
- Concentra Pan Support
- Champagne Gold Aluminium Frame
- Smart Ignition
- I-Link
- Nano Coating
- Fingerprint Resistance



PREMIUM SETAKERA Glass with Champagne Gold Aluminium Frame

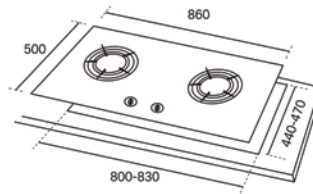

- 5.5kW Flame Power
- Flame Failure Device (FFD) Protection
- Battery Ignition
- FASCO Dritto Flame Style
- Concentra Pan Support
- Champagne Gold Aluminium Frame
- Smart Ignition
- I-Link
- Smart Timer (L/R)
- Nano Coating
- Fingerprint Resistance



PREMIUM SETAKERA Glass with Champagne Gold Aluminium Frame

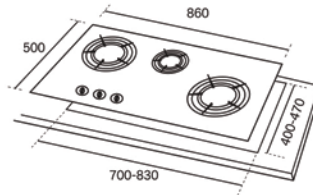

- 5.5kW Flame Power
- Flame Failure Device (FFD) Protection
- Battery Ignition
- FASCO Dritto Flame Style
- Concentra Pan Support
- Champagne Gold Aluminium Frame
- Smart Ignition
- I-Link
- Smart Timer (L/R)
- 3-Burners Parabolic Design
- Nano Coating
- Fingerprint Resistance



PREMIUM Titanium Grey Stainless Steel Surface

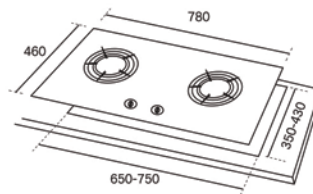

- 5.5kW Flame Power
- Flame Failure Device (FFD) Protection
- Battery Ignition
- FASCO Dritto Flame Style
- Concentra Pan Support
- Smart Ignition
- I-Link



PREMIUM Titanium Grey Stainless Steel Surface

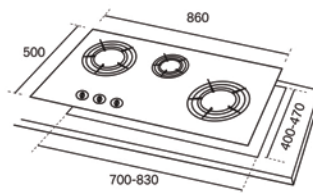

- 5.5kW Flame Power
- Flame Failure Device (FFD) Protection
- Battery Ignition
- FASCO Dritto Flame Style
- Concentra Pan Support
- Smart Ignition
- I-Link
- Smart Timer (L/R)
- 3-Burners Parabolic Design

TOP UP

TOP UP

TOP UP

TOP UP

TOP UP

CALDO SERIES / 2-BURNER / 3-BURNER GAS HOB

TOP UP FROM CALDO2B PACKAGE

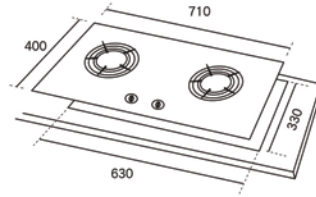

- 5.2kW Flame Power
- Flame Failure Device (FFD) Protection
- Battery Ignition
- Vortex Flame Style
- Pan Support With Wind Barricade

RGH-CALDO2B-SS

- Features**
- L:5.2 R:5.2 Flame Power (kW)
 - Vortex / Twister Flame Style
 - Stainless Steel Surface
 - Stainless Steel + Brass Burner
 - FFD Protection
 - Battery Ignition
 - LPG Gas
 - Cast Iron Pan Support
 - Wok Stand
- Technical Info**
- Product Dimension (mm): 710 W x 400 D
 - Cut-out Dimension (mm): 630 W x 330 D

[LP] WM : RM 890 WM : RM 890
EM : RM 950 EM : RM 950

30 TOP UP

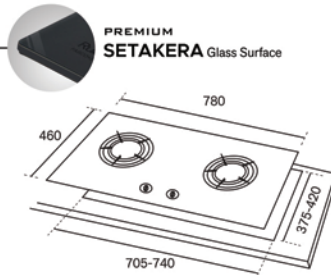

- 6.3kW Flame Power
- 8-Flame Level
- Battery Ignition
- Flame Failure Device (FFD) Protection
- TRIO Ring
- Dritto Flame Style
- Smart/ Auto Ignition
- Flexi Cut-out
- I-Link
- Nano Coating
- Fingerprint Resistance

PREMIUM SETAKERA Glass Surface

RGH-TREZZA2B-SK

- Features**
- L:6.3 R:6.3 Flame Power (kW)
 - Dritto / Straight Flame Style
 - SETAKERA Glass Surface
 - Brass Burner
 - FFD Protection
 - Battery Ignition
 - LPG Gas
 - Cast Iron Pan Support
 - Wok Stand
- Technical Info**
- Product Dimension (mm): 780 W x 460 D
 - Cut-out Dimension (mm): 705-740 W x 375-420 D

[LP] WM : RM 1,580 WM : RM 1,580
EM : RM 1,690 EM : RM 1,690

650 TOP UP

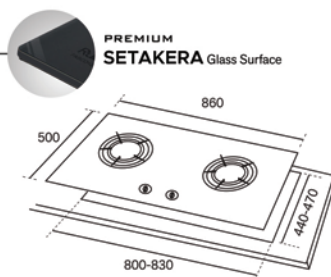

- 6.3kW Flame Power
- 8-Flame Level
- Battery Ignition
- Flame Failure Device (FFD) Protection
- TRIO Ring
- Dritto Flame Style
- Timer
- Smart/ Auto Ignition
- Flexi Cut-out
- I-Link
- Nano Coating
- Fingerprint Resistance

PREMIUM SETAKERA Glass Surface

RGH-DAKKA2B-SK

- Features**
- L:6.3 R:6.3 Flame Power (kW)
 - Dritto / Straight Flame Style
 - SETAKERA Glass Surface
 - Brass Burner
 - FFD Protection
 - Battery Ignition
 - LPG Gas
 - Cast Iron Pan Support
 - Wok Stand
- Technical Info**
- Product Dimension (mm): 860 W x 500 D
 - Cut-out Dimension (mm): 800-830 W x 440-470 D

[LP] WM : RM 1,880 WM : RM 1,880
EM : RM 2,020 EM : RM 2,020

920 TOP UP

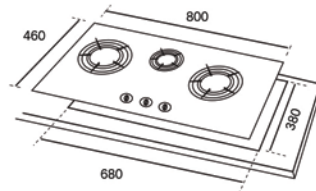
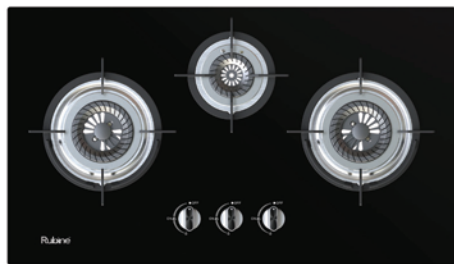

- 5.2kW Flame Power
- Flame Failure Device (FFD) Protection
- Battery Ignition
- Vortex Flame Style
- Pan Support With Wind Barricade

RGH-CALDO3B-BL

- Features**
- L:5.2 M:2.0 R:5.2 Flame Power (kW)
 - Vortex / Twister Flame Style
 - Tempered Glass Surface
 - Stainless Steel + Brass Burner
 - FFD Protection
 - Battery Ignition
 - LPG Gas
 - Cast Iron Pan Support
 - Wok Stand
- Technical Info**
- Product Dimension (mm): 800 W x 460 D
 - Cut-out Dimension (mm): 680 W x 380 D

[LP] WM : RM 1,160 WM : RM 1,160
EM : RM 1,240 EM : RM 1,240

270 TOP UP

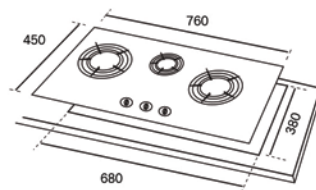

- 5.2kW Flame Power
- Flame Failure Device (FFD) Protection
- Battery Ignition
- Vortex Flame Style
- Pan Support With Wind Barricade

RGH-CALDO3B-SS

- Features**
- L:5.2 M:2.0 R:5.2 Flame Power (kW)
 - Vortex / Twister Flame Style
 - Stainless Steel Surface
 - Stainless Steel + Brass Burner
 - FFD Protection
 - Battery Ignition
 - LPG Gas
 - Cast Iron Pan Support
 - Wok Stand
- Technical Info**
- Product Dimension (mm): 760 W x 450 D
 - Cut-out Dimension (mm): 680 W x 380 D

[LP] WM : RM 1,200 WM : RM 1,200
EM : RM 1,290 EM : RM 1,290

300 TOP UP

GAS HOB

FASCO SERIES

2-BURNER SERIES

3-BURNER SERIES

2-BURNER BUILT-IN GAS HOB

TOP UP FROM **VISTA2B** PACKAGE

RGH-ENYA2B-SS

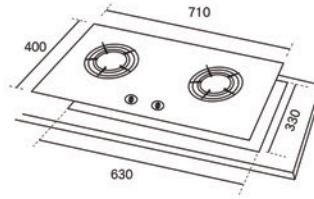

- 5.0kW Flame Power
- Flame Failure Device (FFD) Protection
- Battery Ignition
- Dritto Flame Style

- Features**
- L:5.0 R:5.0 Flame Power (kW)
 - Dritto / Straight Flame Style
 - Stainless Steel Surface
 - Brass Burner
 - FFD Protection
 - Battery Ignition
 - LPG Gas
 - Cast Iron Pan Support
 - Wok Stand
- Technical Info**
- Product Dimension (mm): 710 W x 400 D
Cut-out Dimension (mm): 630 W x 330 D

[LP] WM : RM 830 WM : RM **30**
EM : RM 890 EM : RM **30**

TOP UP

RGH-FIGATA2B-BL

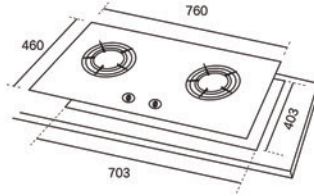

- 5.0kW Flame Power
- Flame Failure Device (FFD) Protection
- Battery Ignition
- Dritto Flame Style
- Convex Burner Plate

- Features**
- L:5.0 R:5.0 Flame Power (kW)
 - Dritto / Straight Flame Style
 - Tempered Glass Surface
 - Brass Burner
 - FFD Protection
 - Battery Ignition
 - LPG Gas
 - Cast Iron Pan Support
 - Wok Stand
- Technical Info**
- Product Dimension (mm): 760 W x 460 D
Cut-out Dimension (mm): 703 W x 403 D

[LP] WM : RM 830 WM : RM **30**
EM : RM 890 EM : RM **30**

TOP UP

RGH-FOTEZ2B-BLFX

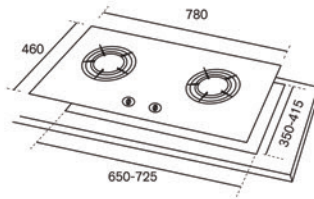

- 5.0kW Flame Power
- Flame Failure Device (FFD) Protection
- Battery Ignition
- Dritto Flame Style
- Smart/Auto Ignition
- Flexi Cut-out
- Wind-guard Stand

- Features**
- L:5.0 R:5.0 Flame Power (kW)
 - Dritto / Straight Flame Style
 - Tempered Glass Surface
 - Brass Burner
 - FFD Protection
 - Battery Ignition
 - LPG Gas
 - Cast Iron Pan Support
 - Cast Iron Wok Stand
- Technical Info**
- Product Dimension (mm): 780 W x 460 D
Cut-out Dimension (mm): 650-725 W x 350-415 D

[LP] WM : RM 1,680 WM : RM **800**
EM : RM 1,800 EM : RM **850**

TOP UP

RGH-LOTOFLEXI2B-BLFX

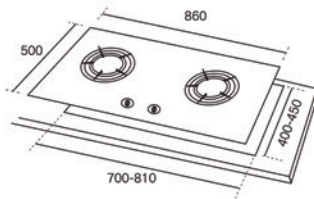

- 5.0kW Flame Power
- Flame Failure Device (FFD) Protection
- Battery Ignition
- Dritto Flame Style
- Smart/Auto Ignition
- Flexi Cut-out

- Features**
- L:5.0 R:5.0 Flame Power (kW)
 - Dritto / Straight Flame Style
 - Tempered Glass Surface
 - Brass Burner
 - FFD Protection
 - Battery Ignition
 - LPG Gas
 - Cast Iron Pan Support
 - Cast Iron Wok Stand
- Technical Info**
- Product Dimension (mm): 860 W x 500 D
Cut-out Dimension (mm): 700-810 W x 400-450 D

[LP] WM : RM 1,680 WM : RM **800**
EM : RM 1,800 EM : RM **850**

TOP UP

2-BURNER BUILT-IN GAS HOB

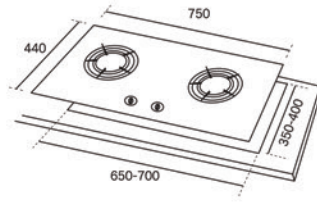
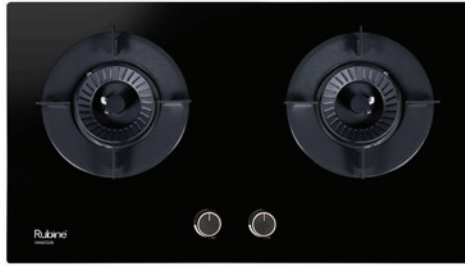

NEW

RGH-VANZO2B-BL

- Features**
- L:5.0 R:5.0 Flame Power (kW)
 - Vortex Flame Style
 - Tempered Glass Surface
 - Stainless Steel + Brass Burner
 - FFD Protection
 - Battery Ignition
 - LPG Gas
 - Cast Iron Pan Support
 - Wok Stand
- Technical Info**
- Product Dimension (mm): 750 W x 440 D
Cut-out Dimension (mm): 650-700 W x 350-400 D

[LP] WM : RM 750
EM : RM 800

VANZO

POWERFUL FLAME WITH
CONCENTRA
PAN SUPPORT

EVEN HEAT DISTRIBUTION

Enjoy perfect cooking experience with powerful flames & even heat distribution.

GAS HOB

3-BURNER BUILT-IN GAS HOB

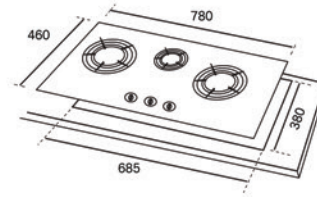
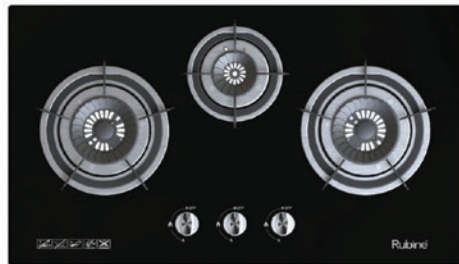

TOP UP FROM **VISTA2B** PACKAGE

RGH-VISTA3B-BL

- Features**
- L:5.0 M:2.0 R:5.0 Flame Power (kW)
 - Vortex/ Twister Flame Style
 - Tempered Glass Surface
 - Stainless Steel + Brass Burner
 - FFD Protection
 - Battery Ignition
 - LPG Gas
 - Cast Iron Pan Support
 - Wok Stand
- Technical Info**
- Product Dimension (mm): 780 W x 460 D
Cut-out Dimension (mm): 685 W x 380 D

[LP] WM : RM 1,030 WM : RM **210**
EM : RM 1,100 EM : RM **220**

TOP UP

FASCO SERIES

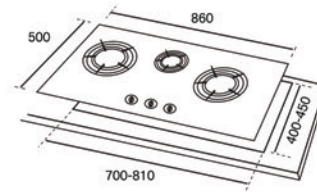

RGH-LOTOFLEXI3B-BLFX

- Features**
- L:5.0 M:1.4 R:5.0 Flame Power (kW)
 - Dritto / Straight Flame Style
 - Tempered Glass Surface
 - Brass Burner
 - FFD Protection
 - Battery Ignition
 - LPG Gas
 - Cast Iron Pan Support
 - Cast Iron Wok Stand
- Technical Info**
- Product Dimension (mm): 860 W x 500 D
Cut-out Dimension (mm): 700-810 W x 400-450 D

[LP] WM : RM 1,850 WM : RM **950**
EM : RM 1,980 EM : RM **1,010**

TOP UP

2-BURNER SERIES

3-BURNER SERIES



ELECTRIC HOB

R-series

PREMIUM ELECTRIC HOB WITH VETRO KERA GLASS

RENZO



MAINTENANCE TIPS

1 GLASS SURFACE CLEANING

Glass surface is easy to clean. Make sure to use only soft cloth / sponge with non-abrasive detergent to avoid damage / scratch the surface.

2 CLEAN UP SPILL AS SOON AS IT OCCURS

Do not use cold water on hot surface as it will create thermal shock that can reduce the life span of the glass. Handle carefully when surface is hot.

3 CLEAN THE BOTTOM OF COOKWARE

Cleanliness of the cookware's bottom is very important as it will affect the heating efficiency.

4 DO NOT DRAG HEAVY COOKWARE ON THE HOB

Always lift cookware off and never slide or drag across the hob surface as they might cause scratches and damage.







ELECTRIC HOB

RIVOLI

QUALITY ELECTRIC HOB, GUARANTEED.

The perfect addition to all modern kitchens today, bringing functionality and elegance as one.



KONSTEC HEAT CONTROL WITH OVERHEATING PROTECTION

With **KONSTEC** heat control technology, the temperature is electronically controlled to provide constant and more uniform distribution of cooking heat. It also comes with a built-in overheat protection sensor to provide extra safety and avoid the vitro-ceramic glass surface being damaged by overheating.

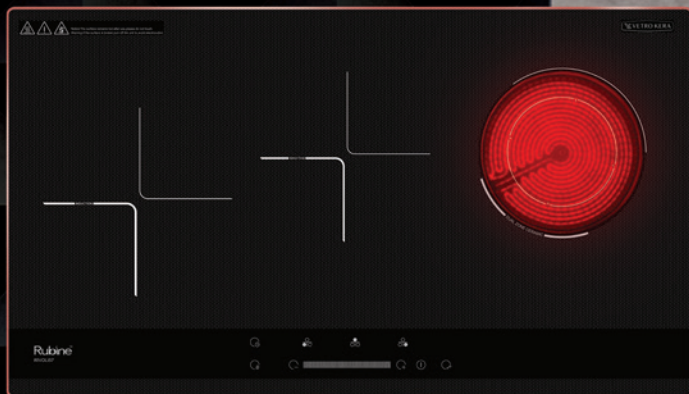

VETRO KERA™

VETRO KERA GLASS

- Evolutionary Glass Surface Design
- Fingerprint & Scratch Resistance
- Exceptional Craftmanship

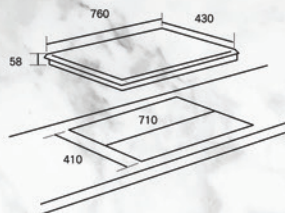
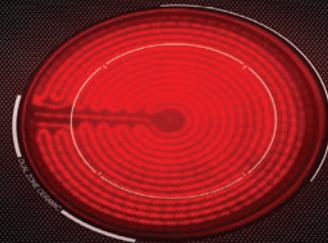

- Safety Lock
- Timer
- Residual Heat Warning Indicator
- Overheat Protection
- KONSTEC Heat Control
- Booster
- Champagne Gold Aluminium Frame

TOP UP FROM **CALDO2B** PACKAGE

BUILT-IN HYBRID HOB

RCH-RIVOLI57-BL

- Features
- Hybrid - Horizontal
 - L: 2.0 (X-Boost) M: 1.7 (X-Boost) R: 2.0 Energy Power Level (kW)
 - 9 Power Level
 - Vitro-Ceramic Glass Surface Material
 - Timer
 - Safety Lock

Technical Info
 Product Dimension (mm): 760 W x 430 D
 Cut-out Dimension (mm): 710 W x 410 D

[LP] WM : RM 1,930
 EM : RM 2,070

WM : RM **960**
 EM : RM **1,030**

TOP UP

R-SERIES

ELECTRIC HOB

R-series

PREMIUM ELECTRIC HOB WITH VETRO KERA GLASS

V-series

PREMIUM ELECTRIC HOB WITH KONSTEC HEAT CONTROL

TOP UP FROM **CALDO2B** PACKAGE

NEW **RENZO** BUILT-IN HYBRID HOB



VETRO KERA
VETRO KERA Glass with Champagne Gold Aluminium Frame

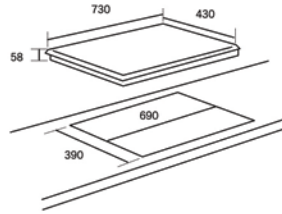

RCH-RENZO42-BL

- Features**
- Hybrid - Horizontal
 - L: 2.2 (X-Boost) R: 2.0
 - Energy Power Level (kW)
 - 9 Power Level
 - Vitro-Ceramic Glass Surface Material
 - Timer
 - Safety Lock

Technical Info
Product Dimension (mm): 730 W x 430 D x 58 H
Cut-out Dimension (mm): 690 W x 390 D

[LP] WM : RM 1,660 WM : RM **720**
EM : RM 1,780 EM : RM **770**

- Safety Lock
- Timer
- Residual Heat Warning Indicator
- Overheat Protection
- KONSTEC Heat Control
- Booster
- Champagne Gold Aluminium Frame

NEW **ROSSE** BUILT-IN CERAMIC HOB



VETRO KERA
VETRO KERA Glass with Champagne Gold Aluminium Frame

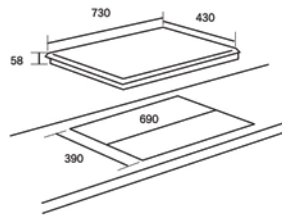

RCE-ROSSE42-BL

- Features**
- Ceramic - Horizontal
 - L: 2.0 R: 2.2 (X-Boost)
 - Energy Power Level (kW)
 - 9 Power Level
 - Vitro-Ceramic Glass Surface Material
 - Timer
 - Safety Lock

Technical Info
Product Dimension (mm): 730 W x 430 D x 58 H
Cut-out Dimension (mm): 690 W x 390 D

[LP] WM : RM 1,660 WM : RM **720**
EM : RM 1,780 EM : RM **770**

- Safety Lock
- Timer
- Residual Heat Warning Indicator
- Overheat Protection
- KONSTEC Heat Control
- Booster
- Champagne Gold Aluminium Frame

NEW **REKKA** BUILT-IN INDUCTION HOB



VETRO KERA
VETRO KERA Glass with Champagne Gold Aluminium Frame

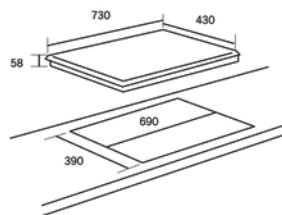

RIH-REKKA44-BL

- Features**
- Induction - Horizontal
 - L: 2.2 (X-Boost) R: 2.2 (X-Boost)
 - Energy Power Level (kW)
 - 9 Power Level
 - Vitro-Ceramic Glass Surface Material
 - Timer
 - Safety Lock

Technical Info
Product Dimension (mm): 730 W x 430 D x 58 H
Cut-out Dimension (mm): 690 W x 390 D

[LP] WM : RM 1,730 WM : RM **780**
EM : RM 1,850 EM : RM **840**

- Safety Lock
- Timer
- Residual Heat Warning Indicator
- Overheat Protection
- Booster
- Champagne Gold Aluminium Frame

Valido series

BUILT-IN HYBRID HOB

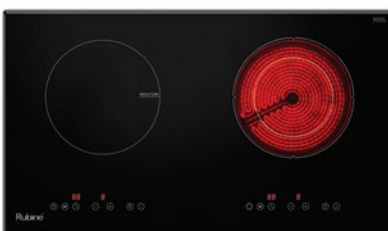

SCHOTT CERAN®
Beveled Glass with Aluminium Frame

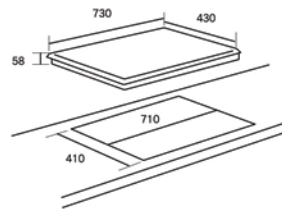

RCH-VALIDO44-BL

- Features**
- Hybrid - Horizontal
 - L: 2.2 (X-Boost) R: 2.2
 - Energy Power Level (kW)
 - 9 Power Level
 - Vitro-Ceramic Glass Surface Material
 - Timer
 - Safety Lock

Technical Info
Product Dimension (mm): 730 W x 430 D x 58 H
Cut-out Dimension (mm): 710 W x 410 D

[LP] WM : RM 2,550 WM : RM **1,520**
EM : RM 2,730 EM : RM **1,630**

- Safety Lock
- Timer
- Booster
- Overheat Protection
- Schott Ceran (Germany)
- Residual Heat Warning Indicator
- E.G.O Heating Element
- Beveled Glass
- Aluminium Frame
- KONSTEC Heat Control

Veloce series

BUILT-IN INDUCTION HOB



SCHOTT CERAN®
Beveled Glass with Aluminium Frame

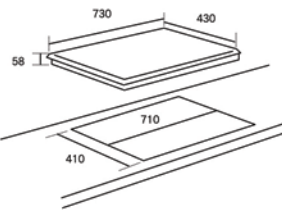

RIH-VELOCE44-BL

- Features**
- Induction - Horizontal
 - L: 2.2 R: 2.2
 - Energy Power Level (kW)
 - 9 Power Level
 - Vitro-Ceramic Glass Surface Material
 - Timer
 - Safety Lock

Technical Info
Product Dimension (mm): 730 W x 430 D x 58 H
Cut-out Dimension (mm): 710 W x 410 D

[LP] WM : RM 2,350 WM : RM **1,340**
EM : RM 2,520 EM : RM **1,440**

- Safety Lock
- Timer
- Booster
- Overheat Protection
- Schott Ceran (Germany)
- Residual Heat Warning Indicator
- Beveled Glass
- Aluminium Frame

TOP UP

TOP UP

TOP UP

TOP UP

TOP UP

Veloce series BUILT-IN INDUCTION HOB

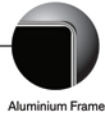
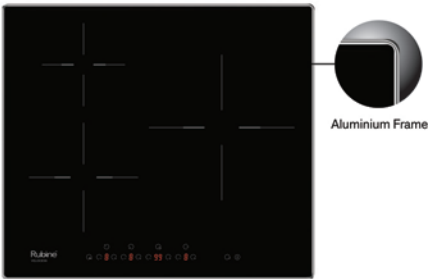

Aluminium Frame

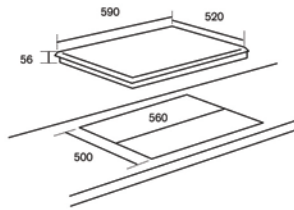

- Safety Lock
- Timer
- Overheat Protection
- Residual Heat Warning Indicator
- AL Aluminium Frame

RIH-VELOCE58-BL

- Features
- Induction - European
 - LF: 2.0 LR: 1.5 R: 2.3
 - Energy Power Level (kW)
 - 9 Power Level
 - Vitro-Ceramic Glass Surface Material
 - Timer
 - Safety Lock

Technical Info
Product Dimension (mm): 590 W x 520 D x 56 H
Cut-out Dimension (mm): 560 W x 500 D

[LP] WM : RM 2,080 WM : RM **1,100**
EM : RM 2,230 EM : RM **1,180**

TOP UP



- Safety Lock
- Timer
- Overheat Protection
- Residual Heat Warning Indicator

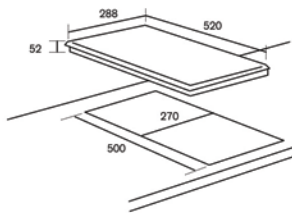

TOP UP FROM **VISTA2B** PACKAGE

RIH-VELOCE35-BL

- Features
- Induction - Domino
 - F: 1.5 R: 2.0
 - Energy Power Level (kW)
 - 9 Power Level
 - Vitro-Ceramic Glass Surface Material
 - Timer
 - Safety Lock

Technical Info
Product Dimension (mm): 288 W x 520 D x 52 H
Cut-out Dimension (mm): 270 W x 500 D

[LP] WM : RM 1,250 WM : RM **410**
EM : RM 1,340 EM : RM **440**

TOP UP

Vulcan series BUILT-IN CERAMIC HOB



- Safety Lock
- Timer
- Overheat Protection
- Residual Heat Warning Indicator
- KONSTEC Heat Control

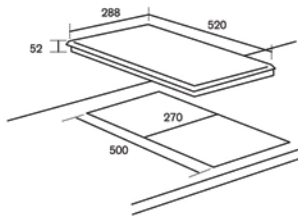

RCE-VULCAN30-BL

- Features
- Ceramic - Domino
 - F: 1.2 R: 1.8
 - Energy Power Level (kW)
 - 9 Power Level
 - Vitro-Ceramic Glass Surface Material
 - Timer
 - Safety Lock

Technical Info
Product Dimension (mm): 288 W x 520 D x 52 H
Cut-out Dimension (mm): 270 W x 500 D

[LP] WM : RM 1,200 WM : RM **360**
EM : RM 1,290 EM : RM **380**

TOP UP



Beveled Glass with Aluminium Frame

- Safety Lock
- Timer
- Overheat Protection
- Residual Heat Warning Indicator
- KONSTEC Heat Control
- Beveled Glass
- AL Aluminium Frame

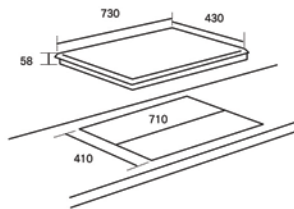

RCE-VULCAN40-BL

- Features
- Ceramic - Horizontal
 - L: 1.8 R: 2.2
 - Energy Power Level (kW)
 - 9 Power Level
 - Vitro-Ceramic Glass Surface Material
 - Timer
 - Safety Lock

Technical Info
Product Dimension (mm): 730 W x 430 D x 58 H
Cut-out Dimension (mm): 710 W x 410 D

[LP] WM : RM 1,550 WM : RM **680**
EM : RM 1,660 EM : RM **730**

TOP UP

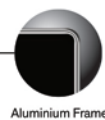
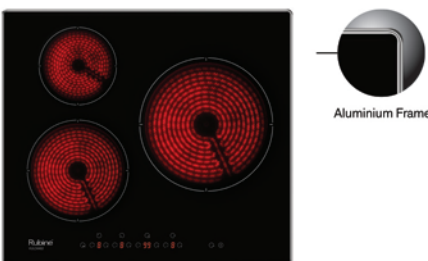

Aluminium Frame

- Safety Lock
- Timer
- Overheat Protection
- Residual Heat Warning Indicator
- AL Aluminium Frame
- KONSTEC Heat Control

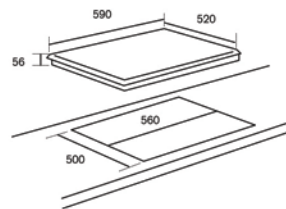

RCE-VULCAN52-BL

- Features
- Ceramic - European
 - LF: 1.8 LR: 1.2 R: 2.2
 - Energy Power Level (kW)
 - 9 Power Level
 - Vitro-Ceramic Glass Surface Material
 - Timer
 - Safety Lock

Technical Info
Product Dimension (mm): 590 W x 520 D x 56 H
Cut-out Dimension (mm): 560 W x 500 D

[LP] WM : RM 2,000 WM : RM **1,090**
EM : RM 2,140 EM : RM **1,160**

TOP UP



SERRA

3-IN-1 COMBI STEAM OVEN

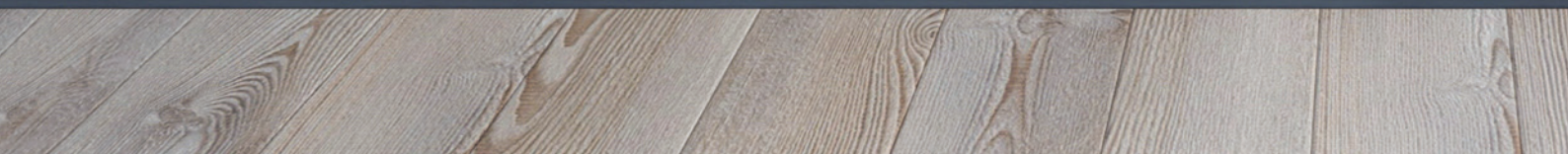
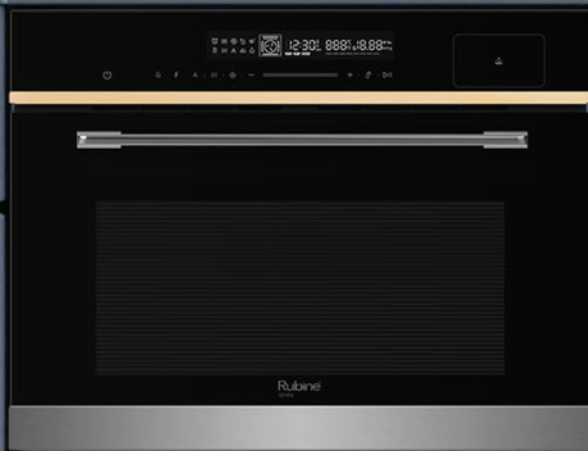
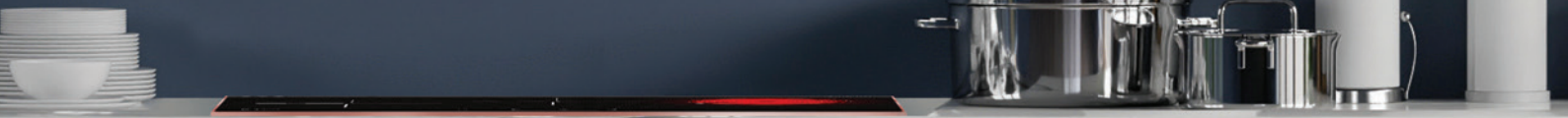



MAINTENANCE TIPS

1 REGULAR CLEANING OF INNER CAVITY

Keep cleanliness of the cavity every time after use to avoid difficulty in removing hard stains.

2 CLEANLINESS OF DOOR GLASS

Use the right degreaser and method to clean oven glass door. Handle with care as the glass is hot after using the oven.

3 CHOOSING THE RIGHT COOKWARE

Use only utensils and containers that are approved and labeled for microwave oven use.

4 KNOW WHAT TO PUT INTO MICROWAVE OVEN

Foods like whole egg, chilli pepper, pasta sauce, sausages and etc are not recommended to cook using microwave, as it will create spillover.

NEW OVEN & MICROWAVE

SERRA

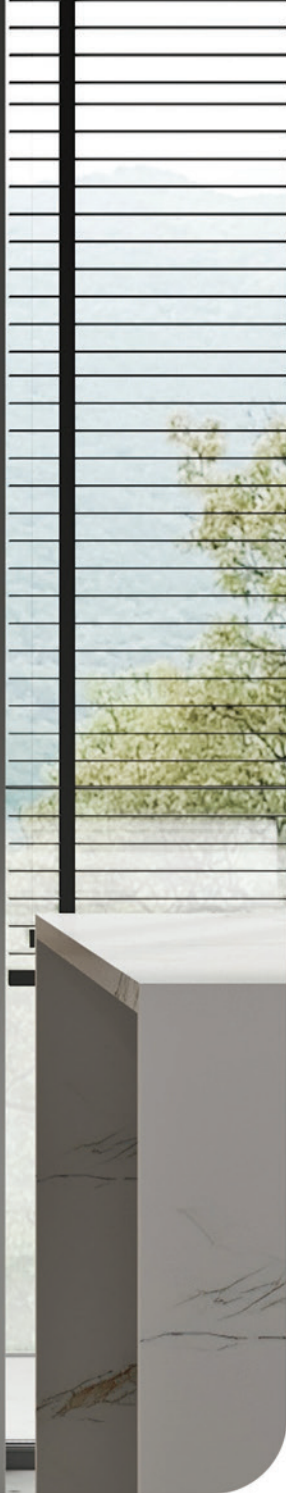

**Lock-in Nutrients
Live Healthier**
Embrace Steam-Powered
Culinary Delights

1 STEAM 2 GRILL 3 FERMENTATION



3-IN-1 COMBI STEAM OVEN

STEAM

- Locks in nutrients and enhance its natural flavour

GRILL

- Satisfies your carnivorous craze effortlessly

FERMENTATION

- Keep temperature at optimum level for dough to proof evenly



<50>
L

50L LARGE CAPACITY

Generously-sized 50L oven accommodates large culinary.



11
FUNCTION

11 COOKING FUNCTIONS

To cater for a variety of cooking.

RSO-SERRA-50BL

Features

- Steam, Grill & Fermentation Oven
- 11 Cooking Functions
- 50 L Capacity
- Sensor Touch Control Panel
- LCD Display
- Oven Light
- Time Control
- Enamel Cavity Material
- Child Lock

Technical Info

Product Dimension (mm)

595 W x 565 D x 454 H

[LP] WM : RM5,320

EM : RM5,630

PWP

WM : RM 4,788

EM : RM 5,128

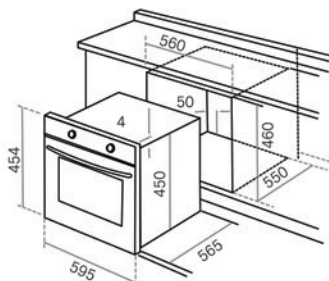

<50>
L

50L Capacity



11 Functions



Child Lock



Steam & Grill

11 COOKING FUNCTIONS



Conventional



Conventional + Fan



Double Grill



Defrost



Convection



Radiant Heat



Bottom Heat + Convection



Fermentation



ECO Convection



Double Grill + Fan



Bottom Heat

NEW

NUOVO



Spice Up New Horizons with Extra Capacity
Expand Culinary Boundaries with Advanced Innovations

RBO-NUOVO-82BL

Features

- Built-in Oven
- 13 Cooking Functions
- 82 L Capacity
- Sensor Touch with Knob Control Panel
- LCD Display
- Oven Light
- Time Control
- Removable Door
- 5 Shelf Side Support
- Enamel Cavity Material

Technical Info

Product Dimension (mm)
595 W x 566 D x 596 H

[LP] WM : RM 3,760
EM : RM 3,990

PWP

WM : **RM 3,368**
EM : **RM 3,608**

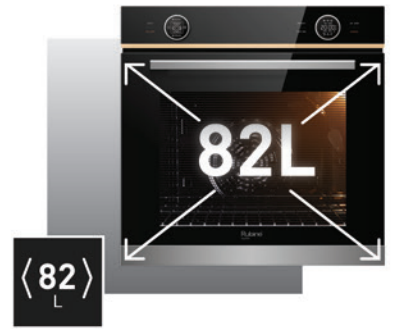
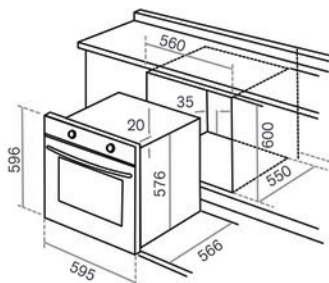

82L LARGE CAPACITY

Generously-sized 82L oven accommodates large culinary.



13
FUNCTION

13 COOKING FUNCTIONS

To cater for a variety of cooking.



INTUITIVE KNOB CONTROL WITH SENSOR TOUCH

- 82L Capacity
- 13 Functions
- 5 Shelves Side Support
- Quality 3-Layers Glass Door
- Cooling System
- Rotisserie & Turnspit
- Child Lock

13 COOKING FUNCTIONS

- | | | | |
|----------------|--------------------|--------------|---------------|
| Conventional | Conventional + Fan | Double Grill | Defrost |
| Convection | Radiant Heat | Pizza | Fermentation |
| ECO Convection | Double Grill + Fan | Bottom Heat | LIGHT PREHEAT |

NEW OVEN & MICROWAVE

BECCA



Baking Paradise

Discover the Wonders of Air Frying & 3D Cooking



AIR FRYER SYSTEM



83L LARGE CAPACITY

Generously-sized 83L oven accommodates large culinary.



3D COOKING EFFECT

RBO-BECCA-83BL

Features

- Built-in Oven
- 10 Cooking Functions
- 83 L Capacity
- Mechanical Control Panel
- Oven Light
- Time Control
- Removable Door
- 5 Shelf Side Support
- Enamel Cavity Material

Technical Info

Product Dimension (mm)
594 W x 498 D x 594 H

[LP] WM : RM 2,530
EM : RM 2,680

PWP

WM : RM 2,268
EM : RM 2,428

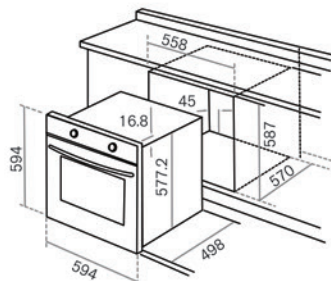

83L Capacity



10 Functions



5 Shelves Side Support



Quality 3-Layers Glass Door



Cooling System



Air Fryer



3D Cooking Effect

10 COOKING FUNCTIONS



Light



Conventional + Fan



Double Grill



Air Fry



Defrost



Radiant Heat



Double Grill + Fan



Conventional



Dehydration



Pizza

BUILT-IN OVEN

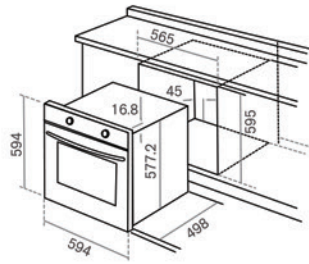

- 60L Capacity
- 7 Functions
- A-Class Energy Efficiency
- 5 Shelves Side Support
- Quality 2-Layers Glass Door
- Cooling System
- Rotisserie & Turnspit

RBO-CAVO-60BL

Features

- Built-in Oven
- 7 Cooking Functions
- 60 L Capacity
- Mechanical Control Panel
- Oven Light
- Time Control
- Removable Door
- 5 Shelf Side Support
- Enamel Cavity Material
- A-Class Energy Efficiency

Technical Info

Product Dimension (mm)
594 W x 498 D x 594 H

[LP] WM : RM 1,650
EM : RM 1,750

PWP
WM : **RM 1,488**
EM : **RM 1,598**

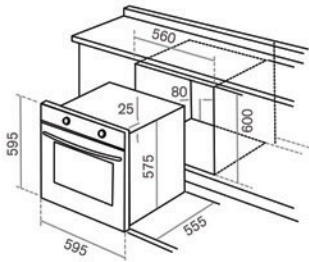

- 70L Capacity
- 8 Functions
- A-Class Energy Efficiency
- 5 Shelves Side Support
- Quality 2-Layers Glass Door
- Cooling System
- Rotisserie & Turnspit

RBO-LAVA-70SS

Features

- Built-in Oven
- 8 Cooking Functions
- 70 L Capacity
- Mechanical Control Panel
- Oven Light
- Time Control
- Removable Door
- 5 Shelf Side Support
- Enamel Cavity Material
- A-Class Energy Efficiency

Technical Info

Product Dimension (mm)
595 W x 555 D x 595 H

[LP] WM : RM 2,110
EM : RM 2,230

PWP
WM : **RM 1,898**
EM : **RM 2,038**

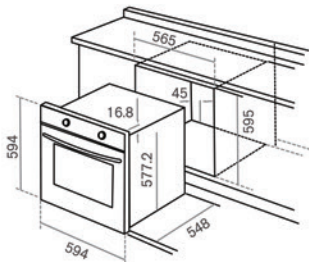

- 70L Capacity
- 8 Functions
- A-Class Energy Efficiency
- 5 Shelves Side Support
- Quality 3-Layers Glass Door
- Cooling System
- Rotisserie & Turnspit
- Telescopic Runner

RBO-IA8X-70SS

Features

- Built-in Oven
- 8 Cooking Functions
- 70 L Capacity
- Mechanical + Digital Control Panel
- LCD Display
- Oven Light
- Time Control
- Removable Door
- 5 Shelf Side Support
- Enamel Cavity Material
- A-Class Energy Efficiency

Technical Info

Product Dimension (mm)
594 W x 548 D x 594 H

[LP] WM : RM 2,790
EM : RM 2,960

PWP
WM : **RM 2,508**
EM : **RM 2,688**

BUILT-IN MICROWAVE

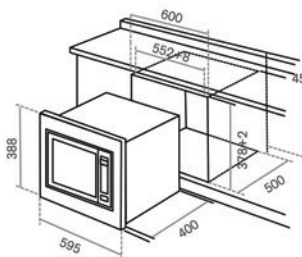
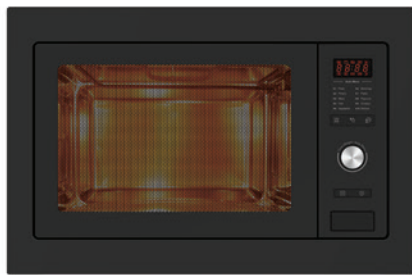

- 28L Capacity
- 8 Auto Menu
- Child Lock
- 30 Sec Quick Start
- Cooling System

RMO-OREO-28BL

Features

- Built-in Microwave with Grill
- 8 Auto Menu
- 28 L Capacity
- Electronic Control Panel
- LCD Display
- Oven Light
- Time Control
- Stainless Steel Cavity Material
- Child Lock

Technical Info

Product Dimension (mm)
595 W x 400 D x 388 H

[LP] WM : RM 1,440
EM : RM 1,530

PWP
WM : RM 1,298
EM : RM 1,388

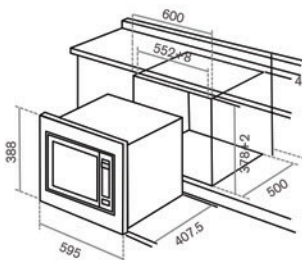

- 34L Capacity
- 8 Auto Menu
- Child Lock
- 30 Sec Quick Start
- Cooling System

RMO-934SS-GD34X

Features

- Built-in Microwave with Grill
- 8 Auto Menu
- 34 L Capacity
- Electronic Control Panel
- LCD Display
- Oven Light
- Time Control
- Stainless Steel Cavity Material
- Child Lock

Technical Info

Product Dimension (mm)
595 W x 407.5 D x 388 H

[LP] WM : RM 1,750
EM : RM 1,860

PWP
WM : RM 1,578
EM : RM 1,688



ONLINE REGISTRATION

- ① Log on to www.rubine.com.my
- ② Click on 'Support', followed by 'Warranty Registration' to proceed. You're required to sign up as a member.
- ③ Please fill up the necessary information, tick on the checkbox and click 'Sign Up'.
- ④ You'll receive notification of warranty registration confirmation via email.
- ⑤ Your warranty will be automatically extended for another 1 year upon online registration. Please keep your online warranty certificate for future services.

* Please find out from our authorized dealers for extended warranty!

OUR WARRANTY



6 YEARS OF WARRANTY
APPLICABLE ON
HOOD MOTOR ONLY.



5 YEARS OF WARRANTY
APPLICABLE ON
TEMPERED GLASS OF GAS HOB ONLY.



18 MONTHS OF STANDARD WARRANTY
APPLICABLE ON ALL PRODUCTS
EXCLUDING ACCESSORIES.



1 YEAR OF WARRANTY EXTENSION
REGISTER ONLINE NOW AND GET
1 YEAR WARRANTY EXTENSION !

CUSTOMER CARE & WAYS TO REACH TO US



AFTER-SALES SERVICE

Contact: 03 – 6286 9000
Email: eqservice@fiamma.com.my



OPERATION HOURS

08.30am – 06.00pm
Monday–Friday, except public holiday



WAYS TO REACH US

Whenever you think of kitchen appliances, please pay a visit to your nearest Rubine store or find us online to get instant inquiry: rubine.com.my



*Product images for illustration purposes only.



REDEFINE THE WAY OF LIFE

2024 V.3





rubine.com.my



FIAMMA TRADING SDN BHD 330476-P [A member of Fiamma Holdings Berhad]

2-1, Wisma Fiamma, No.20, Jalan 7A/62A, Bandar Manjalara, 52200 Kuala Lumpur.

 [rubinemalaysia](https://www.facebook.com/rubinemalaysia)

 03-6286 9000